

# SHIFTER STICKS

## LIGHT WEIGHT ALUMINUM STICKS

Hurst aluminum shifter sticks are more resilient than steel in competition use, and are one-third lighter. 2024 aluminum heat treated to T-6. Ultimate tensile strength 68,000 psi. All aluminum sticks incorporate a 7/16 - 20 thread size.

**BLACK ANODIZED ALUMINUM FINISH**

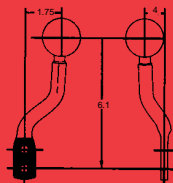

#538 0202 Used on shifter 391 0031

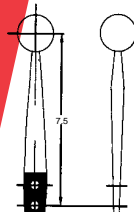

#538 0196 Used on shifter 391 0032

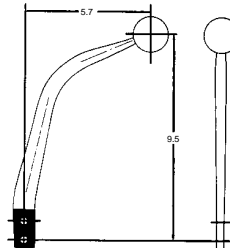

#538 0201 Used on shifter 391 0029

**NATURAL ALUMINUM FINISH**

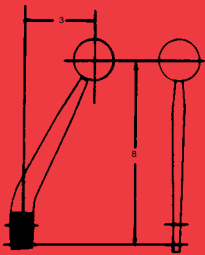

#538 0178 Used on shifters 366 0005, 391 8790

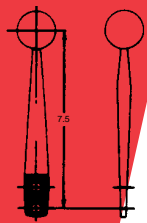

#538 0185 Used on shifters 391 7535, 391 0003, 391 7960, 491 0001

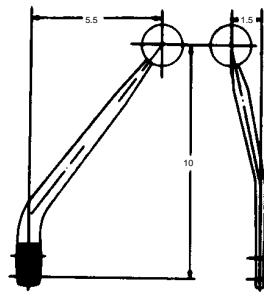

#538 0179 Used on shifters 391 4339, 391 7879, 366 4550

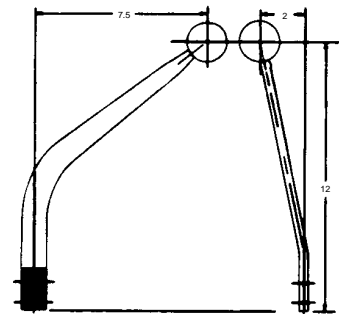

#538 0180 Used on shifters 391 8034, 366 8034

## CHROME-PLATED STEEL STICKS

Hurst Chrome plated steel sticks are constructed from a high strength steel and manufactured with Hurst quality. Embossed with the Hurst name, all steel sticks incorporate a 3/8-16 thread size for use with a variety of Hurst T-Handles and shifter knobs.

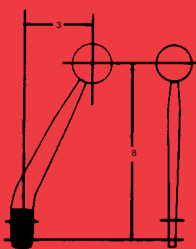

#538 0015 Used on shifters 391 8790, 366 0005

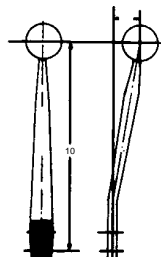

#538 7991 Used on shifter 391 7992

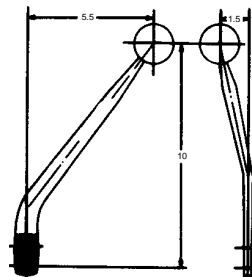

#538 4106 Used on shifters 391 4339, 391 7879, 366 4550

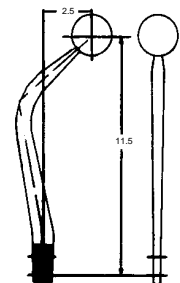

#538 7236 Used on shifters 391 7308, 391 7307, 391 7930, 366 7271

# SHIFTER STICKS

## CHROME-PLATED STEEL STICKS

All Hurst Chrome-Plated Steel Sticks Are 3/8-16 Thread.

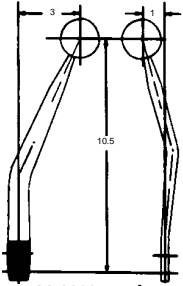

#538 8009 Used on shifter 391 8014

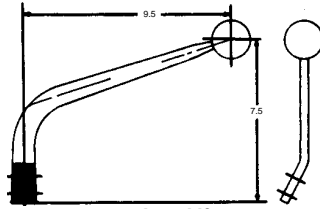

#538 6643 Used on shifter 391 6642

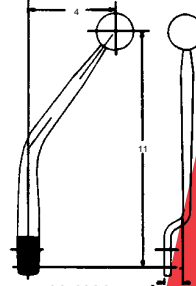

#538 6836 Used on shifters 391 6822, 391 7072, 391 6848

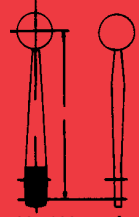

#538 7238 Used on shifters 391 7535, 391 0003, 391 7960 91 0001

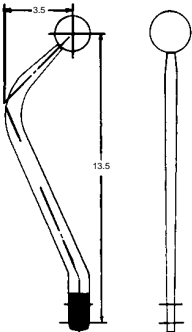

#538 6900 Used on shifters 366 6901, 391 8403, 391 8404

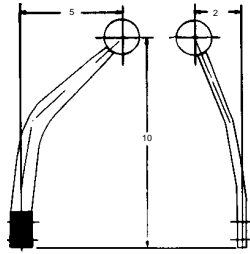

#538 7436 Used on shifters 391 7438, 366 7954

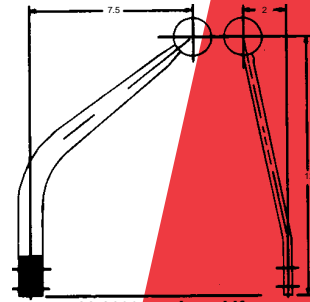

#538 8022 Used on shifters 391 0014, 366 8034

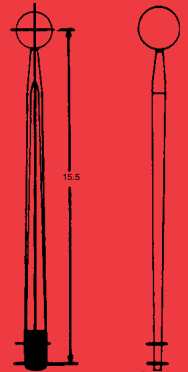

#538 0060 Used on shifter 366 0010

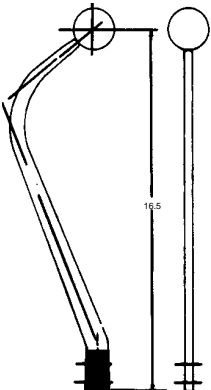

#538 4331 Used on shifters 391 0001, 391 0002, 366 6809

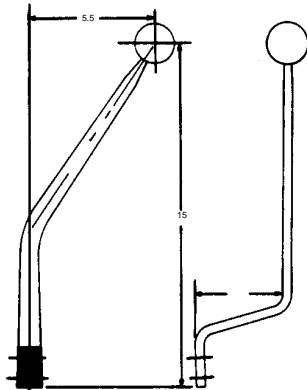

#538 4084 Used on shifter 391 6790

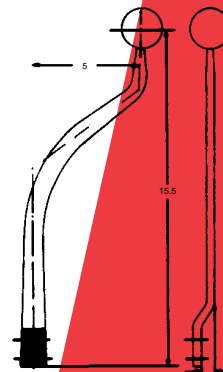

#538 4077 Used on shifter 391 6788

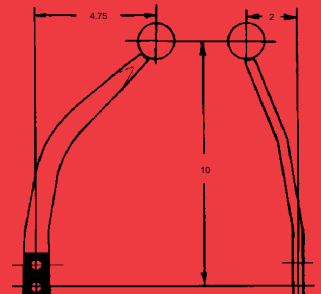

#538 0100 Used on shifter 407 0009

# SHIFTER STICKS

## CHROME-PLATED STEEL STICKS

All Hurst Chrome-Plated Steel Sticks Are 3/8-16 Thread.

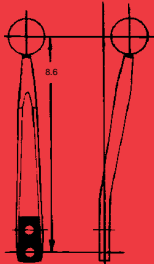

#538 0131 Used on shifter 391 0028



#538 0085 Used on shifters 391 0014, 391 0024

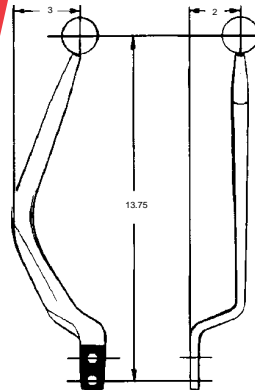

#538 0221

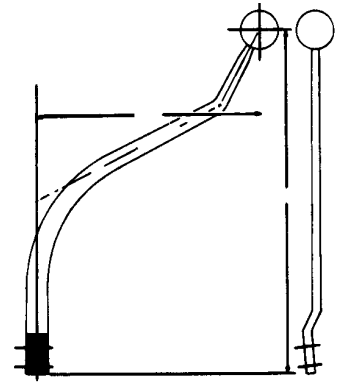

#538 4078 Used on shifter 391 6789

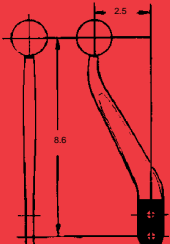

#538 8550 Used on shifter 391 0035, 391 0036

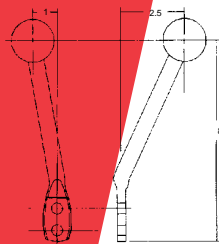

#538 8570 Black Chrome Used on shifter 391 0060

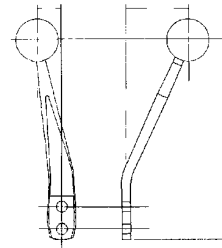

#538 8571 Used on shifter 391 0061

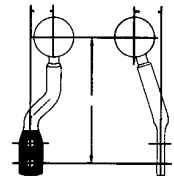

#538 0197 Black E-coated 7/16-20 thread Used on shifter 391 0030

